



NVF2 Inverter

1. General

NVF2 series inverter is a high-performance open-loop vector inverter developed by our company. It features high starting torque (0.5Hz, 1.5 times rated torque), high overload capacity, convenient operation and forward and reverse PID control. It has smaller volume and good environmental adaptability.

This series includes two types of frequency converters, constant torque type and fan and pump type, and features good load adaptability, stable and reliable operation and automatic energy-saving operation. The products are widely used in electric drive and automation control fields, such as paper making, textile, water supply, municipal administration, food, cement, printing and dyeing and plastic machinery.

The products are designed and tested in accordance with international standards and tested by simulating the actual service conditions.

The products comply with the standards IEC 61800-2.

2. Type designation

NVF2-□/□ □ □

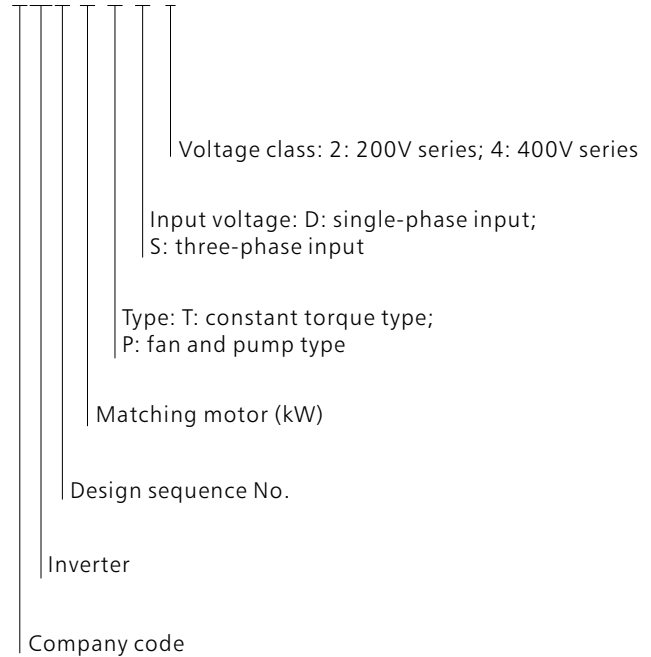

3. Operating conditions

3.1 Temperature

The inverter should be used at an ambient temperature of $-10^{\circ}\text{C} \sim +40^{\circ}\text{C}$ and derated by 1% per 1°C above 40°C .

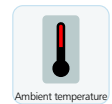

Ambient temperature

3.2 Humidity

The relative air humidity should be $\leq 95\%$, and no condensation should occur.



Altitude

3.3 Altitude

The inverter can produce the rated power when installed below the altitude of 1000m. It should be derated by 10% per 1000m above 1000m.



No Radiation

3.4 Impact and vibration

The inverter should not be dropped to the ground or subjected to sudden impact. It should not be installed in places where vibration may occur.



No Water spraying

3.5 Electromagnetic radiation

The inverter should not be installed adjacent to electromagnetic radiation sources.



No Pollution

3.6 Water and vapor protection

The inverter should not be installed in places where drenching or condensation occurs.

3.7 Air pollution

The inverter should not be installed in places with air pollution, such as dust or corrosive gas atmosphere.



No Direct Sunshine

3.8 Storage environment

The inverter should not be stored in places with direct sunlight, oil mist, steam or vibration.

4. Technical data

4.1 NVF2 Series Inverter - Specifications

Input voltage class	three-phase 380V													
Model NVF2-/T(P)S4	0.4	0.75	1.5	2.2	3.7	5.5	7.5	11	15	18.5	22	30	37	
Applicable motor power (kW)	0.4	0.75	1.5	2.2	3.7	5.5	7.5	11	15	18.5	22	30	37	
T Type, Rated output current (A)	1.2	2.5	3.7	5	9	13	17	25	32	37	45	60	75	
P Type, Rated output current (A)	1.2	2.5	3.7	5	9	11	17	22	32	37	45	60	75	
Max. output voltage (V)	Corresponding three-phase input voltage													
Output frequency range (Hz)	Constant torque type: (0~400)Hz; fan and pump type: (0~120)Hz													
Carrier frequency kHz (1~15)	8								4					
Cooling	Forced air cooling													

Input voltage class	three-phase 380V													
Model NVF2-/T(P)S4	45	55	75	90	110	132	160	185	200	220	245	280	315	
Applicable motor power (kW)	45	55	75	90	110	132	160	185	200	220	245	280	315	
T Type, Rated output current (A)	90	110	150	176	210	253	300	340	380	420	470	520	600	
P Type, Rated output current (A)	90	110	140	176	210	253	300	340	380	420	470	520	600	
Max. output voltage (V)	Corresponding three-phase input voltage													
Output frequency range (Hz)	Constant torque type: (0~400)Hz; fan and pump type: (0~120)Hz													
Carrier frequency kHz (1~15)	4		2											
Cooling	Forced air cooling													

4.2 NVF2 Series Inverter - Standard Technical Characteristics

Input and Output Characteristics	Input Voltage Range: 440V/380V/220V(±15%)
	Input Frequency Range: (47~63)Hz
	Output Voltage Range: 0~Rated input voltage
	Output Frequency Range: Constant torque: (0~400)Hz Fans, pump: (0~120)Hz
Peripheral Interface Characteristics	Programmable Digital Input: 6 inputs
	Programmable Analog Input: AI1: (0~10)V input, AI2: (0~10)V or (0/4~20)mA input; A11+A12
	Open Collector Output: 1 output
	Relay Output: 2 outputs
Functional Characteristics	Analog Output: 2 outputs, (0/4~20)mA or (0~10)V optional
	Frequency Setting: digital setting, analog setting, serial communication setting, multi-speed, PID setting, etc.
	Forward & Reverse PID Control Function
	Multi-speed Control Function: 8-speed control
	Wobble frequency control function for textile machine
	Auto Voltage Regulation Function: automatically maintain the constant output voltage when the grid voltage varies
	Over 20 Failure Protection Functions: over-current, over-voltage, under-voltage, over-temperature, phase loss, overload, PID wire breakage, etc.
Technical Characteristics	Control Method: Non-PG vector control, V/F control
	Overload Capacity: Constant torque, 60s at 150% rated current; Fans, pump: 60s at 120% rated current;
	Starting Torque: Non-PG vector control: 0.5Hz 150% (starting torque)
	Speed Ratio: Non-PG vector control: 1:100: V/F 1:50
	Speed Control Precision: Non-PG vector control: ±0.5% max. speed
Carrier Frequency: (1.0~15.0)kHz	



5 Product features

- 5.1 Open-loop vector technique with motor self-learning function, which enables accurate and stable operation of the motor.
- 5.2 Large low-frequency torque (1.5 times rated torque at 0.5Hz) and high overload capacity, suitable for low-speed high-load and high-speed discontinuous load operation.
- 5.3 Independent air duct design, high heat dispersion performance, moulded case design, high dustproof performance, good environmental adaptability.
- 5.4 Low inductance structural design, high immunity.
- 5.5 Standard RS485 MODBUS communication.
- 5.6 Built-in simple PID and swing frequency control function, which makes the machine suitable for various applications.
- 5.7 Operating time accumulation function, which enables switching between display of relevant data.
- 5.8 Automatic energy-saving operation function, which achieves significant energy-saving effect in specific light load applications.
- 5.9 Compact and smooth appearance, which meets the aesthetic features of industrial products.
- 5.10 Detachable keyboard, which can be pulled out and realize remote monitor.



5.11 Standard connection diagram

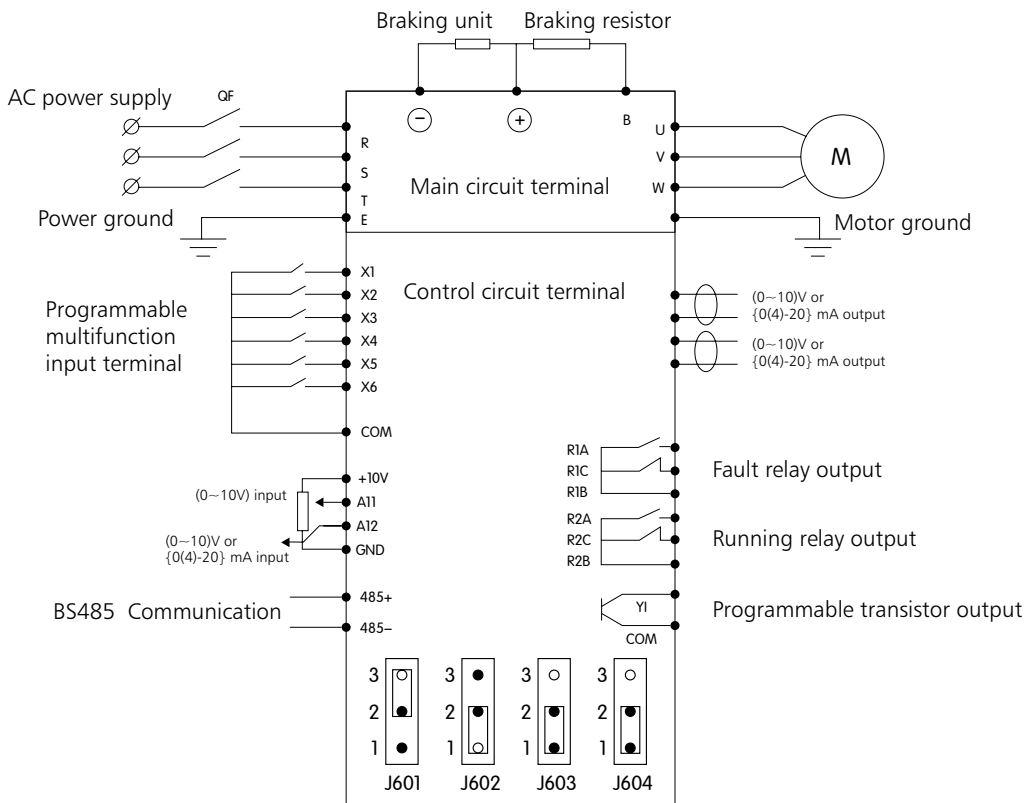

J601 position (AI1 interface): 1 connected to 2: 0V~10V analog voltage input;

2 connected to 3: 0 (4) mA~20mA analog current input

J602 position (AI2 interface): 1 connected to 2: 0V~10V analog voltage input of AI1; 2 connected to 3: panel potentiometer input

J603 position (AO1 interface): 1 connected to 2: 0V~10V analog voltage output; 2 connected to 3: 0 (4) mA~20mA analog output

J604 position (AO2 interface): 1 connected to 2: 0V~10V analog voltage output; 2 connected to 3: 0 (4) mA~20mA analog output

5.12 Description of control circuit terminals

Terminal marking	Terminal name	Description
R1A,R1B,R1C R2A,R2B,R2C	Relay contact output	RB and RC are a group of N/O contacts, RA and RB are a group of N/C contacts, whose functions are set via parameters F6.01 and F6.02. The default value is fault state signal output.
Y1,CCOM	Open collector output	The function is set via parameter F6.00, the default value is forward rotation signal output.
485+,485-	Serial communication terminal	Terminal for serial communication with the outside.
+10V AI1,GND	Power supply for frequency setting Analog signal input terminal	Connect to the potentiometer together with AI1, AI2, GND (4.7kΩ~10kΩ) Connect to the potentiometer or 0V~10V signal, as frequency setting, PID setting or PID feedback
A01,A02,GND	Analog signal output terminal	Input 0V~10V/0(4)mA~20mA signal, as frequency setting, PID setting or PID feedback
AO,GND	Multifunction input terminal	Connect to DC10V 0mA~20mA (4mA~20mA) voltmeter between AO and GND Can be used to indicate operating frequency, output current, output voltage, etc.
X1	Multifunction input terminal	The default setting is forward rotation operation
X2	Multifunction input terminal	The default setting is forward rotation inching
X3	Multifunction input terminal	The default setting is fault reset
X4	Multifunction input terminal	The default setting is no function
X5	Multifunction input terminal	
X6	Multifunction input terminal	
COM	Multifunction input terminal common ground	Common ground of X1-X6, the common ground is used in combination with X1-X6
24V,COM	24V auxiliary power supply output	24V DC power supply output (≤50mA)

5 Overall and mounting dimensions

Opening size of NVF2 display box

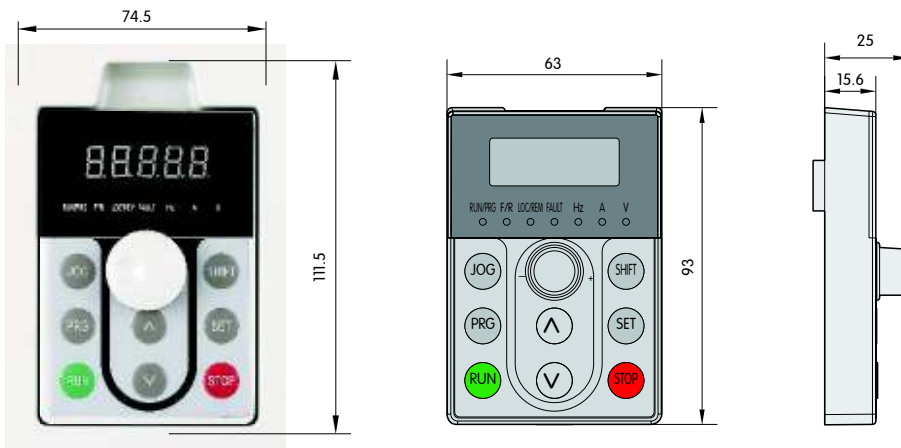

NVF2-0.4/TS4~11/PS4

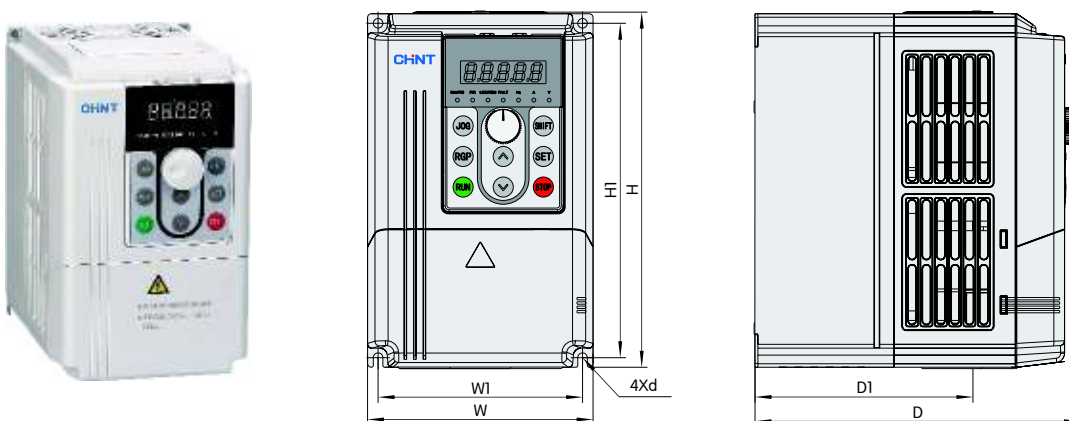

NVF2-11/TS4~220/PS4

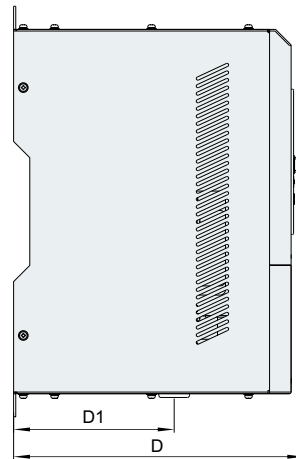
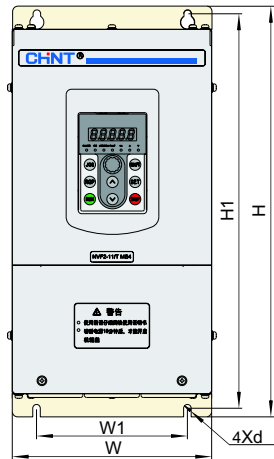

NVF2-220/TS4~355/PS4

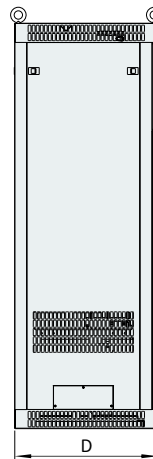
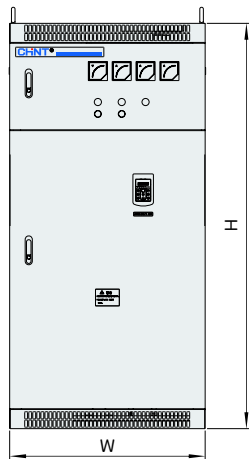

Model	Dimensions						
	W	H	D	W1	H1	D1	d
NVF2-0.4/TS4	118	187	173	107	175	110	5
NVF2-0.75/TS4							
NVF2-1.5/TS4							
NVF2-2.2/T(P)S4							
NVF2-3.7/T(P)S4							
NVF2-5.5/PS4	155	247	189	140	232	125	6
NVF2-5.5/TS4							
NVF2-7.5/T(P)S4							
NVF2-11/PS4	194	381	270	140	366	150	7
NVF2-11/TS4							
NVF2-15/PS4							
NVF2-15/TS4	222	426	290	140	410	168	7
NVF2-18.5/PS4							
NVF2-18.5/TS4							
NVF2-22/PS4							
NVF2-22/TS4							
NVF2-30/PS4	300	596	345	210	568	210	9
NVF2-30/TS4							
NVF2-37/PS4							
NVF2-37/TS4	355	701	395	280	664	220	9
NVF2-45/PS4							
NVF2-45/TS4							
NVF2-55/PS4							
NVF2-55/TS4							
NVF2-75/PS4	395	750	410	300	716	190	9
NVF2-75/TS4							
NVF2-90/PS4							
NVF2-90/TS4	485	920	445	400	880	230	12
NVF2-110/PS4							
NVF2-110/TS4							
NVF2-132/PS4							
NVF2-132/TS4							
NVF2-160/PS4	590	1080	475	450	1040	230	12
NVF2-160/TS4							
NVF2-185/PS4							
NVF2-185/TS4	850	1800	600	—	—	—	—
NVF2-200/PS4							
NVF2-200/TS4							
NVF2-220/PS4							
NVF2-220/TS4							
NVF2-245/PS4	850	1800	600	—	—	—	—
NVF2-245/TS4							
NVF2-280/PS4							
NVF2-280/TS4	850	1800	600	—	—	—	—
NVF2-315/PS4							
NVF2-315/TS4							

